

SKY TRACKER

GPS VIDEO DRONE



AUTO
HOVER



ONE KEY
RETURN



RANGE



HEADLESS
MODE



GPS
TRANSMISSION



APP
CONTROL



FOLLOW ME
MODE



ARTICULATING
WIDE ANGLE VIEW



DRC445
USER MANUAL

PRE-FLIGHT CHECKLIST

Before attempting to fly your drone, make sure that you have done all of the following:

Charged Your Remote's Battery

See page 6 of this manual for more information.

Charged Your Drone's Battery

See page 6 of this manual for more information.

Checked That the Propellers are Firmly Attached

See page 17 of this manual for more information.

Calibrated Your Drone with the Remote Control

See page 9 of this manual for more information.

Calibrated Your Drone's Gyroscope

See page 9 of this manual for more information.

Calibrated Your Drone's GPS

See page 10 of this manual for more information.

Unlocked Your Drone

See page 10 of this manual for more information.



WARNING!

Failure to calibrate your drone before flight can lead to severe flight malfunctions and potential damage to your drone. Always fly carefully!

1. Introduction

Thank you for purchasing the Sky Tracker GPS Video Drone, item DRC445. The included remote controlled aircraft is designed specifically for outdoor flying. In order to get the best possible results, please read this user's manual carefully before using. In addition, be sure to keep this manual in a safe place for future reference.

2. Features

- 16 Minute Flight Time
- Follow Me Technology
- 720p HD Video
- Auto Takeoff and Landing
- Real Time Transmission
- Headless Mode Directional Lock
- Variable Speed Settings
- GPS
- 1000Ft Range

3. Package Contents

- DRC445 Drone
- Remote Control
- 7.4V Li-polymer Battery For Drone
- Protecting Ring x4
- Extra Rotor Blades x4
- USB Charging Cable
- Landing Gear x2
- User's Manual with Warranty Information

4. Important Safety Precautions

When using your Sky Tracker GPS Video Drone, basic safety precautions should always be followed, including the following:

1. Do not allow children or the infirm to operate your drone without adult supervision. For safety purposes, only allow experienced pilots aged 14 and up fly your drone.
2. To avoid choking hazards, keep all small parts and pieces away from children.
3. Your drone is not a toy. Make sure that it is properly assembled before use, and operated safely.
4. Keep your drone away from obstacles, crowds, power lines, trees, and bodies of water while it is in flight. Always fly your drone in a wide open spacious environment. Avoid flying your drone directly above people or animals. Maintain a 7ft (2m) distance from the aircraft when taking off and landing.
5. Only use your drone in a dry environment. Your drone is composed of sophisticated electronic components and parts. To avoid damage to your drone, please keep your drone away from water and moisture. Use a soft dry cloth to wipe the surface of your drone and keep it clean.
6. Beginner and novice level pilots should practice flying with experienced pilots until suitably experienced in flight.
7. To ensure safety, only use the included parts when using your drones.
8. Make sure to keep your ears and eyes protected when using your drone. When your drone's blades are spinning, make sure to keep people and objects at a distance from rotating parts.
9. Keep your drone away from excessive heat or flames, especially while charging the battery.
10. Please recycle or dispose of your drone properly based on the laws and rules of your municipality. Contact local recycling facilities and/or the manufacturer of your drone for further information.

BATTERY SAFETY WARNING

- When handled incorrectly, lithium polymer batteries can be dangerous and can potentially harm and do damage to persons or property. The manufacturer of your drone does not accept any liability for damage to persons or property if the battery is not correctly charged, stored or protected.
- Always unwind all cables before charging.
- Do not over charge the battery. Once the charging process is completed, remove the battery from the charger as soon as possible.
- Only use the included or replacement Sky Tracker charging cable and batteries.
- You must charge the lithium polymer battery in a safe area away from flammable materials.
- The battery is only to be charged under adult supervision, do not leave charging batteries unattended. You should always remain in constant observation to monitor the charging process and react immediately to any potential problems that may occur.
- Do not charge the battery in temperatures hotter than 40°C or colder than 0°C.
- Do not cover the batteries when charging. Do not leave batteries in direct sunlight.
- After each flight and/or crash, please check the battery for any damage or swelling. If the battery is damaged, leaking, making noise, punctured or malformed in any way DO NOT attempt to use it. Please dispose of the battery immediately and safely.
- Do not bend, puncture, crush or scratch the drone's battery. Do not store batteries in your pockets, on your person or in extreme temperatures.
- After flying/discharging the battery you must allow it to cool to ambient room temperature before recharging.
- If at any time during the charge or discharge process the battery begins to balloon or swell, discontinue charging or discharging immediately. Quickly and safely disconnect the battery, then place it in a safe, open area away from flammable materials to observe it for at least 15 minutes. Continuing to charge or discharge a battery that has begun to balloon or swell can result in a fire. A battery that has ballooned or swollen even a small amount must be removed from service completely.
- Never plug in a battery and leave it to charge unattended overnight.
- Non-compliance with the above warnings may result in the failure of the battery.

5. A Quick Look at Your Remote Control

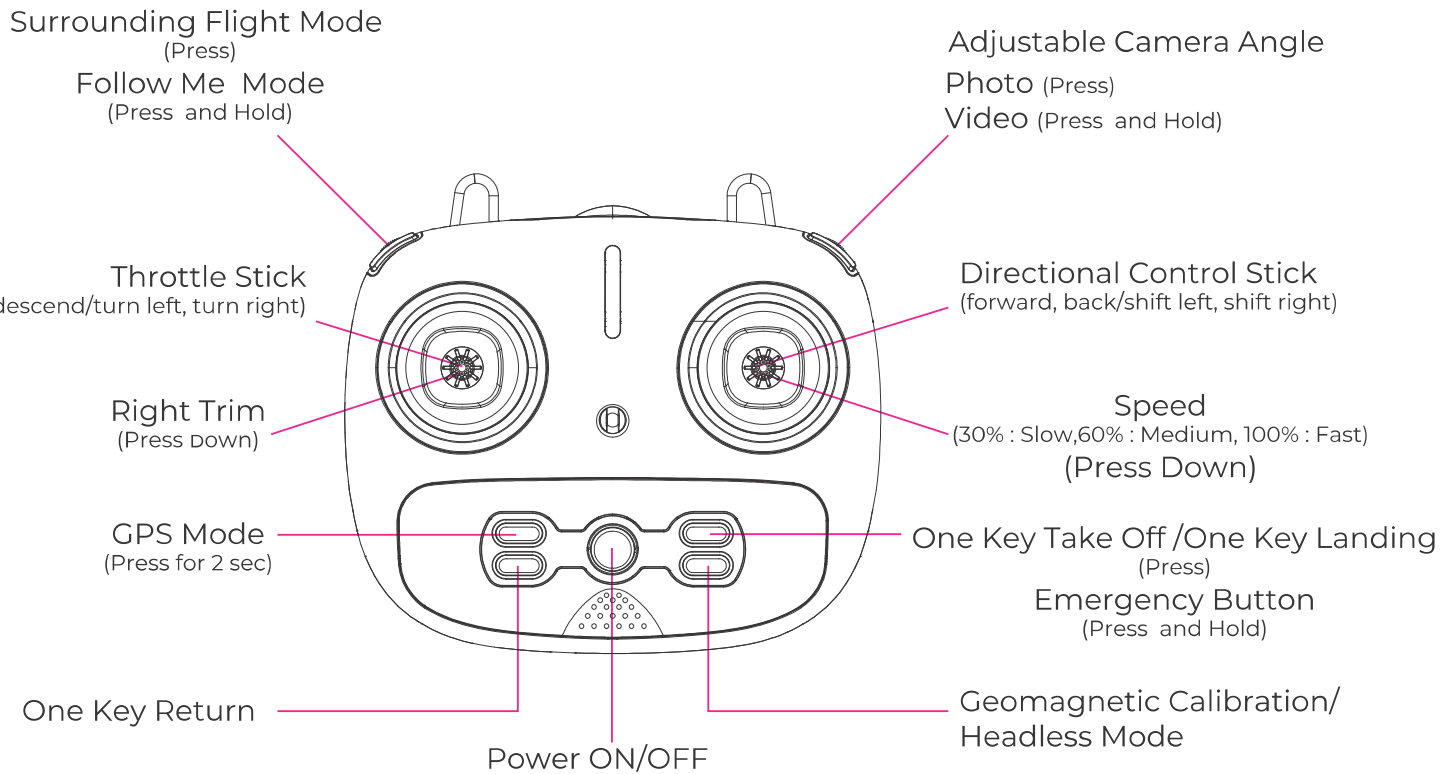

6. A Quick Look at Your Drone

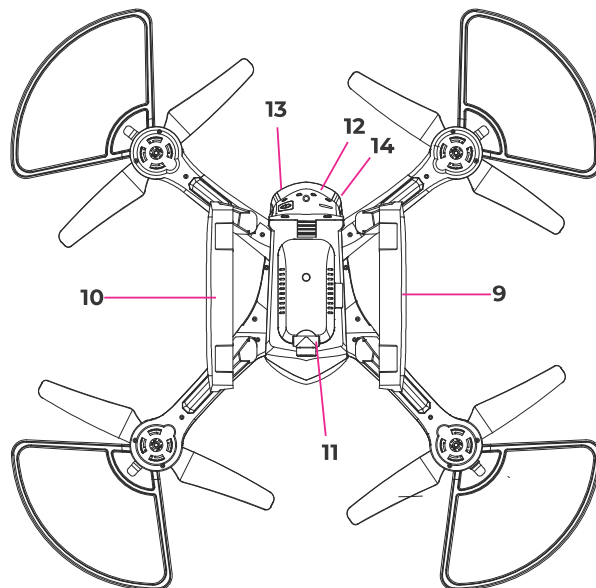
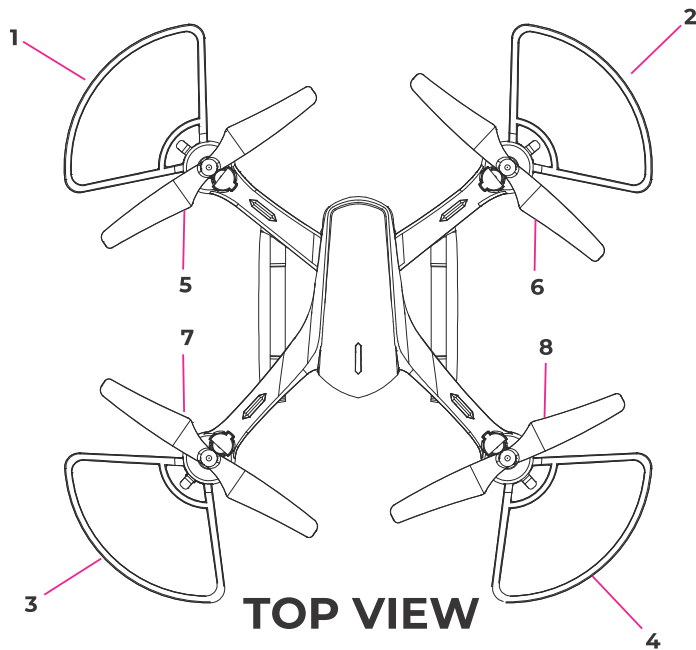

BOTTOM VIEW

1. Rear Right Protecting Ring
2. Rear Left Protecting Ring
3. Front Right Protecting Ring
4. Front Left Protecting Ring
5. Rear Right Rotor Blade
6. Rear Left Rotor Blade
7. Front Right Rotor Blade
8. Front Left Rotor Blade
9. Right Landing Gear
10. Left Landing Gear
11. Camera
12. Battery
13. Power Button
14. Battery Release

7. Charging

Charging the Remote Control

Insert one end of the USB charging cable into the charging port of the remote control. Plug the other end into any computer USB port.

NOTE: Do not turn on the battery when charging.

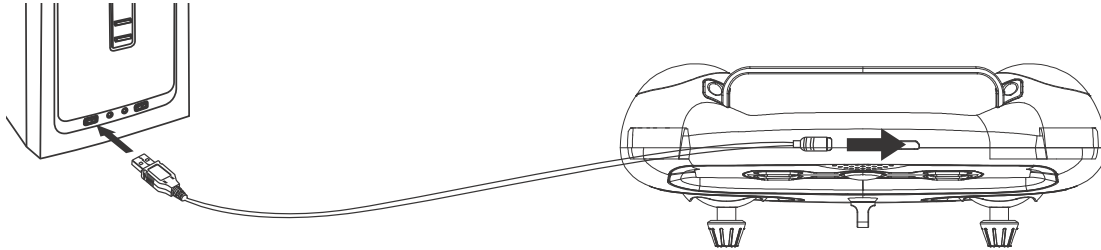

Charging the Drone's Battery

Connect the battery to one end of the included charging cable. Then plug the the other end into a USB charging adapter (not included). For best results, use a 5V, 1-2A charger to charge the battery.

While charging, an LED light on the charger will illuminate. This light will turn off once charging is complete. Charging typically takes approximately 3-4 hours

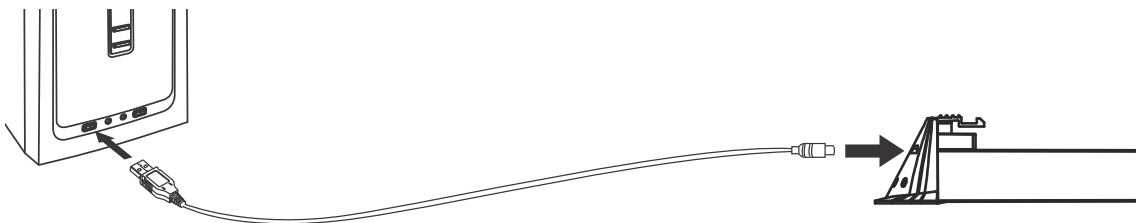

WARNING:

1. The charging plug can overheat if overcharged. If this occurs unplug the charger immediately to avoid damaging the battery.
2. Do not leave the battery unattended when charging.
3. Do not use other chargers other than the one supplied.
4. Wait at least 30 minutes after using your drone before charging the battery. The battery's temperature can become elevated during use and charging it immediately could damage the battery.
5. Remove the drone's battery when the drone is not in use. Store it in a cool dry place.
6. Do not leave the battery exposed to excessive heat, flame or fire.
7. Do not short circuit the battery. Do not leave the battery in contact with any metal parts.

8. Using the Skytracker Drone App

Go to the Apple App Store or Google Play store and search for the Skytracker Drone app. Follow the instructions to proceed to download the app.



Using Wi-Fi to Connect the Drone to Your Phone

-Press the power button on your drone to power it on.

-When the drone is powered on (without the remote control powered on), the lights on the arms of the drone will flash. While these lights are flashing the WiFi signal will become available for connection.

-In your Smartphone's Wi-Fi settings menu, make sure that Wi-Fi is turned on, and find and select the drone network connection.

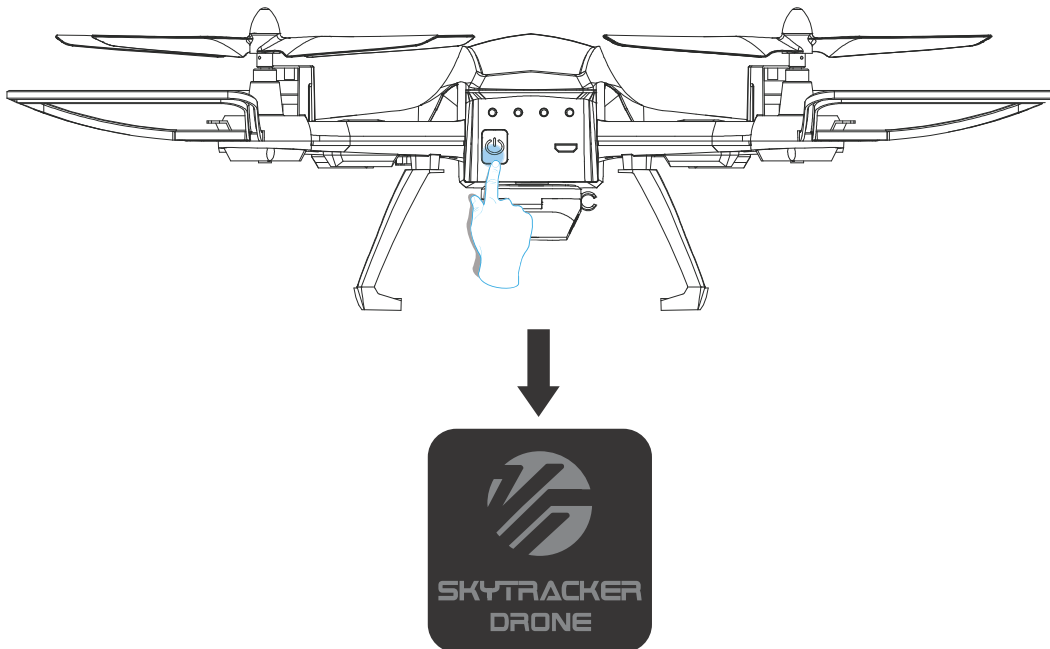

Open the Skytracker software application.

9. Control Interface Functions

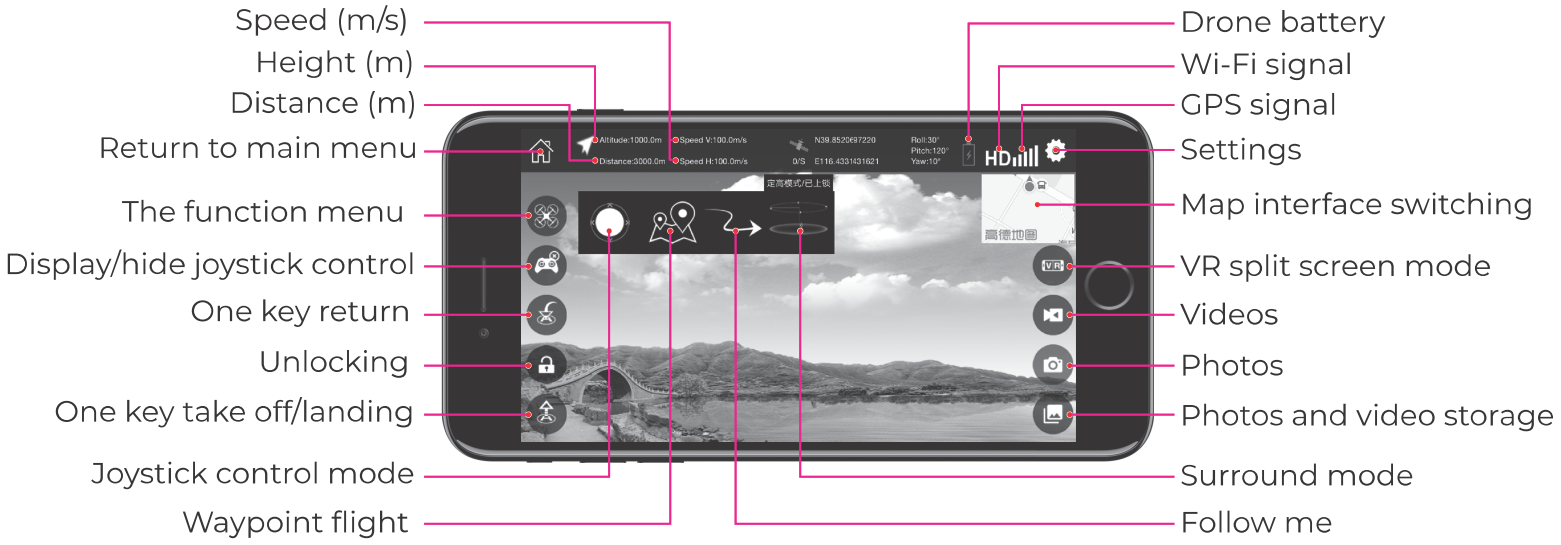

10. Calibrating Your Drone (Preparing for Flight)

Before preparing your drone for flight, first make sure that you have a suitable environment for flight. Avoid flying in rain or snow, or in windy conditions. Stay away from people, trees, power lines, tall buildings, airports and signal towers.

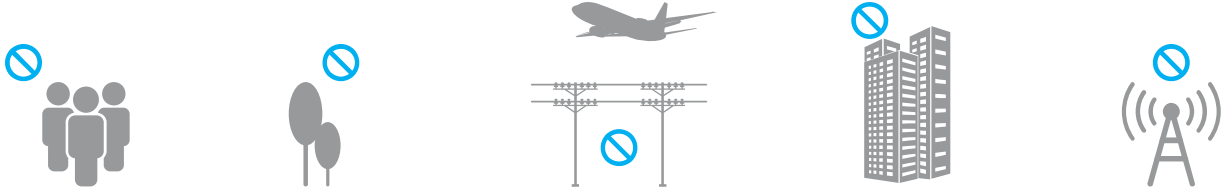

To power on your remote control, press the Power ON/OFF button. You will hear a beep when it powers on. To power on your drone, press and hold the power button. The LED light on the drone flashes rapidly. Once your drone and remote control are powered on, follow the calibration steps below in order to prepare your drone for flight.

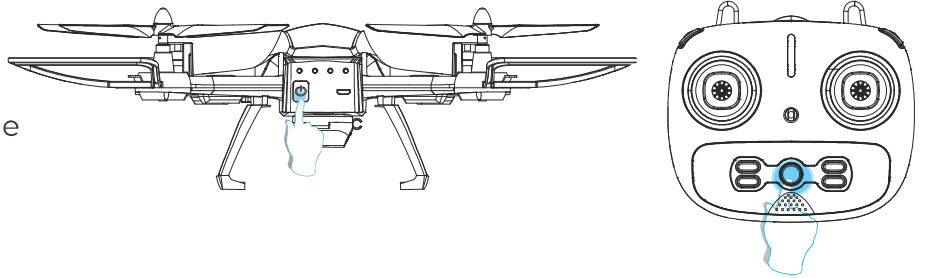

Calibrating Your Drone with Your Remote Control

-With your drone and remote both powered on, pull the throttle stick on the remote control all the way up and then push it all the way down and hold it down.

-When you hear your remote make a beeping sound, then your drone is synchronized with your remote control .

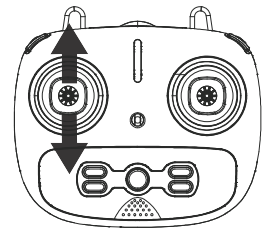

Calibrating Your Drone's Internal Gyroscope

Calibrate your drone's internal gyroscope to ensure smooth and balanced flight. Before you start, make sure your drone is placed on a flat, stable surface.

-Pull the throttle stick and the directional stick all the way down and to the left simultaneously. Release them after about 10 seconds. You will notice that lights on your drone will flash as you are holding down the sticks, and will stop flashing and remain illuminated once the gyroscope is calibrated.

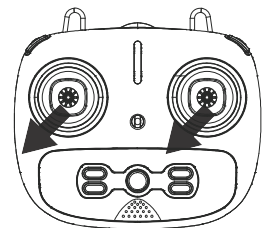
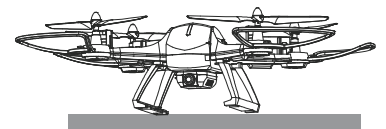

Note: If your drone takes off and flies without corresponding remote control command, you may need to retry calibrating the gyroscope.

11. Geomagnetic Calibration

The drone's geomagnetic calibration allows your drone to be tracked over GPS. Before you start, make sure your drone is placed on a flat, stable surface.

-Press and hold the geomagnetic calibration button on the remote control. The remote will make a beeping sound, and a light on the drone will begin to flash. At this point you can begin the geomagnetic calibration process.

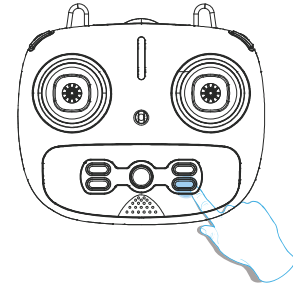

-Rotate your drone horizontally, spinning it in a clockwise direction continuously until the white lights on the front of your drone will keep flashing, while the lights on the back of your drone will solidly shine yellow.

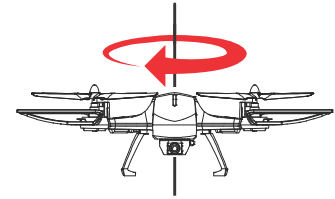

-Turn the head downwards and rotate your drone vertically, spinning it continuously until the white lights on the front of your drone and the yellow lights on the back of your drone both stop blinking and continue to shine steadily. Calibration is complete.

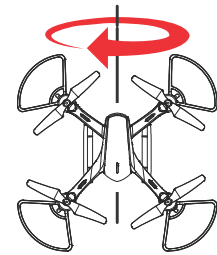

WARNING

- When flying your drone in GPS mode, make sure you are in a wide open space.
- Do not calibrate your drone in areas where there are strong magnetic fields.
- When calibrating, do not carry ferromagnetic materials such as keys or cell phones.
- Do not calibrate near large sheets of metal.

Unlocking Your Drone

Once the remote is paired and your drone is calibrated, the motors will need to be unlocked before you fly. To unlock the motors, move the left stick all the way down and to the right. At the same time move the right stick all the way down and to the left.

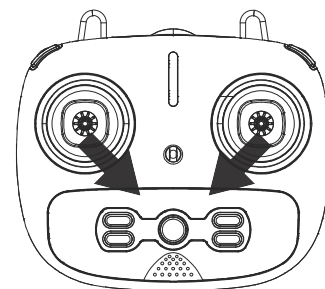

12. Flying Your Drone

Pre-Flight Preparation

If you have never used a drone before and you are not an experienced pilot, make sure to read these instructions carefully before flying. Get familiar with all of the controls. If necessary, read through these instructions many times and practice handling the remote control until you feel completely comfortable and ready.

1. Place your drone in a clear, open field. Make sure that it is resting on a secure, flat surface.
2. Practice using the throttle stick and the directional control stick (see below).
3. By simulating the use of the remote and both sticks, you will grow more comfortable with the natural motions required during flight and you will learn to react more rapidly to unexpected circumstances.

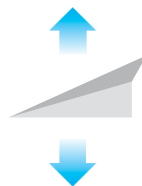
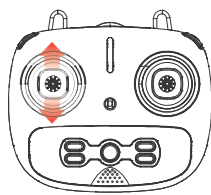
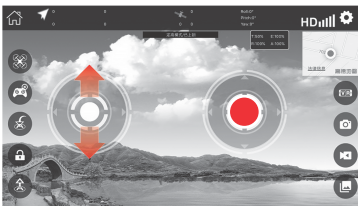

Push the throttle stick upwards and the drone will ascend.

Pull the throttle stick downwards and the drone will descend.

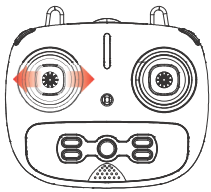
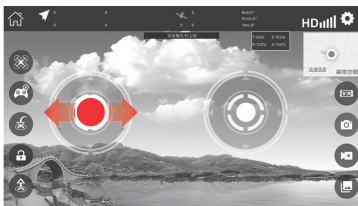

Slide the throttle stick to the left to turn the nose of the drone, turning it to the left. Slide the throttle stick to the right and the nose of the drone will turn to the right.

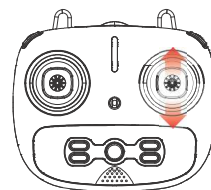
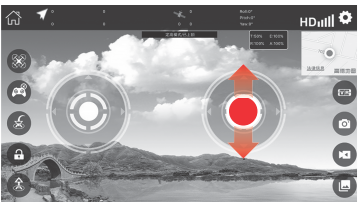

Push the directional control stick upwards and the drone will tilt downwards, causing it to move forward. Push the directional control stick downwards and the drone will tilt upwards, causing it to move backwards.

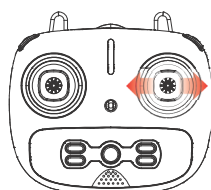
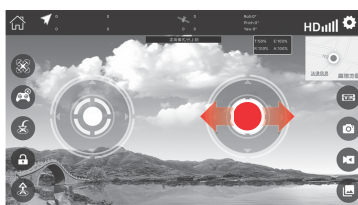

Slide the directional control stick to the left and the entire body of the drone will slide to the left.

Slide the directional control stick to the right and the entire body of the drone will slide to the right.

ALTITUDE HOLD

Altitude hold works while you are flying your drone to help the drone hover and maintain a constant height making aerial photography easy.

To implement altitude hold, allow the left thumb stick to fall back to its default middle position while flying, and the drone will balance itself to hold its altitude.

13. One Key Takeoff & Landing

Once your drone is unlocked, you can press the One Key Takeoff button and the drone will automatically hover 1 meters above the ground.

By pressing the One Key Landing button, your drone will automatically land on the ground.

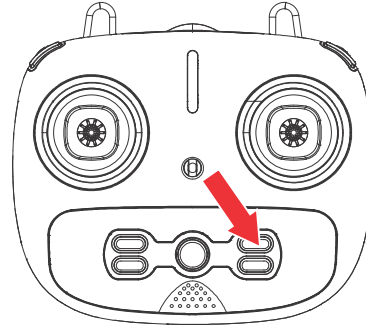

NOTE: Make sure your drone is properly calibrated before attempting to fly.

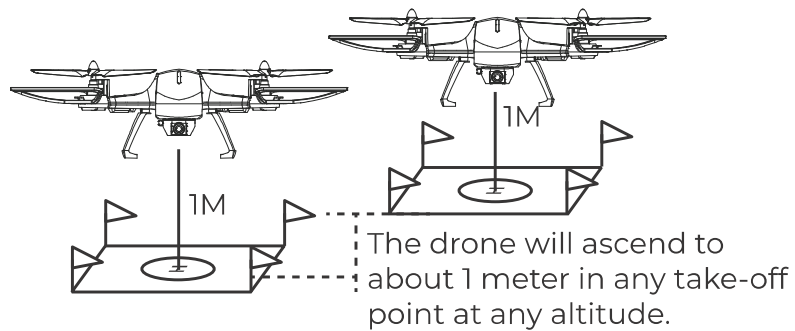

14. One Key Return

While flying your drone, press and hold the One Key Return button on the remote to start a return flight. The drone will travel directly back to where it started.

PLEASE NOTE: It is important that the GPS is correctly calibrated before launch and before activating one key return. Failing to do so may result in the drone flying away when one key return is attempted.

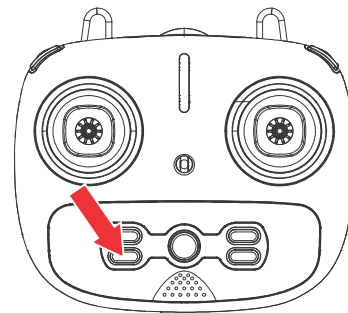
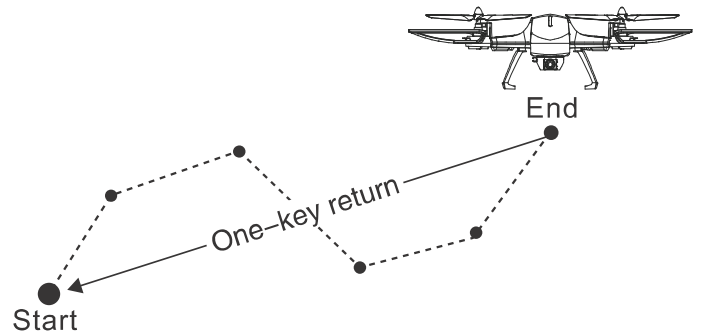

15. Speed Adjustment

Your drone has three speed modes. To cycle through the speed modes, press down the right throttle to change speeds. Each mode will be identifiable by a series of beeps. The original speed for the drone is low speed, press the right throttle once to change one speed.

Low Speed Mode: One beep
Medium Speed Mode: Two beeps
High Speed Mode: Three Beeps

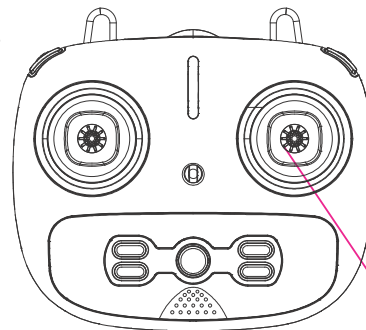

Speed
(30% : Slow, 60% : Medium, 100% : Fast)
(Press Down)

16. Emergency Stop Function

If your drone is flying abnormally, crashes, or otherwise cannot be controlled, press and hold the Emergency button on your remote control to trigger an emergency stop.

PLEASE NOTE: When using any landing functions, make sure that there are no obstacles, people or animals under the drone.

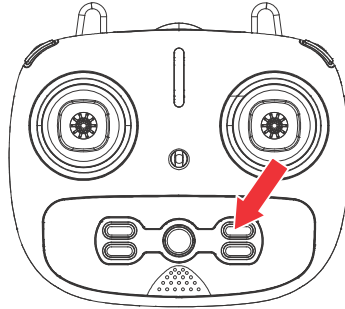

17. Controller Alerts

When the remote control battery is low, it will emit a beeping sound, signalling that the batteries need to be replaced.

When the drone's battery is running low: In GPS mode, the drone will fly back automatically. In general mode, the back LED light will turn red and flash.

PLEASE NOTE: Do not ignore low power warnings. Doing so may result in unplanned landings.

18. Motor Lockdown

When the rotor-blades are stopped by an obstacle the motors will go into a protective lock down mode.

To unlock the motors make sure the rotor-blades are clear from debris and put the drone back on the ground. Once you are ready to fly again pull the left thumb stick all the way down and the motors will release.

19. Point of Interest

When activated, point of interest will make the drone circle around a desired point of interest. To activate point of interest aim the drone at the desired point of interest and then press the right thumb stick in like a button and the controller will beep.

While in Point of Interest mode the left thumb stick is used only to control the drone's height and the right thumb stick is used to control the direction and speed that the drone circles the target and how close the drone is to the target

22. Propeller Blade Installation

If your propeller blades become damaged or the drone is no longer flying straight, the blades may need to be replaced. To replace the propeller blades please follow the directions below.

1. Remove the motor hat and the screw securing the rotor blade, and lift the blade off taking note whether the blade that is being replaced is an 'A' blade or a 'B' Blade. Press the replacement blade onto the stem making sure that the screw holes align and the replacement rotor blade is the same ('A' or 'B') as the original rotor blade. Once the rotor blade is in position replace the securing screw.

Vivitar One Year Warranty

This warranty covers the original consumer purchaser only and is not transferable.

This warranty covers products that fail to function properly UNDER NORMAL USAGE, due to defects in material or workmanship. Your product will be repaired or replaced at no charge for parts or labor for a period of one year.

What Is Not Covered by Warranty

Damages or malfunctions not resulting from defects in material or workmanship and damages or malfunctions from other than normal use, including but limited to, repair by unauthorized parties, tampering, modification or accident.

To Obtain Warranty Service and Troubleshooting Information:

Call 1-800-592-9541 in the U.S. or visit our website at www.vivitar.com.

To receive Warranty service along with the name and address of an authorized product service center, the original consumer purchaser must contact us for problem determination and service procedures. Proof of purchase in the form of a bill of sale or receipted invoice, evidencing that the product is within the applicable Warranty period(s), MUST be presented in order to obtain the requested service. It is your responsibility to properly package and send any defective products along with a dated copy of proof of purchase, a written explanation of the problem, and a valid return address to the authorized service center at your expense. Do not include any other items or accessories with the defective product. Any products received by the authorized service center that are not covered by warranty will be returned unrepairs.

FCC Compliance Statement

Changes or modifications not expressly approved by the party responsible for compliance could void the user's authority to operate the equipment.

This device complies with Part 15 of the FCC Rules. Operation is subject to the following two conditions: (1) this device may not cause harmful interference, and (2) this device must accept any interference received, including interference that may cause undesired operation.

This equipment has been tested and found to comply with the limits for a Class B digital device, pursuant to Part 15 of the FCC Rules. These limits are designed to provide reasonable protection against harmful interference in a residential installation. This equipment generates, uses and can radiate radio frequency energy and, if not installed and used in accordance with the instructions, may cause harmful interference to radio communications. However, there is no guarantee that interference will not occur in a particular installation.

If this equipment does cause harmful interference to radio or television reception, which can be determined by turning the equipment off and on, the user is encouraged to try to correct the interference by one or more of the following measures:

- Reorient or relocate the receiving antenna.
- Increase the separation between the equipment and receiver.
- Connect the equipment into an outlet on a circuit different from that to which the receiver is connected.
- Consult the dealer or an experienced radio/TV technician for help.

