

iHome

AUTOVAC

JUNO



For support content and the latest digital copy of this manual, scan the QR code above or visit iHomeclean.com

Owner's Guide

Model iHRV9



TABLE OF CONTENTS

1 - 2.....	Safety
3	In The Box
4	Product Overview
5	Dustbin Overview
6	Robot Indicators
7 - 8.....	Setting up the Charging Dock
9	Setting Up The AutoVac Juno
10.....	Using the iHOME CLEAN App
11	Main Brush Maintenance
12	Maintaining the Dustbin and Filters
13	Side Brush and Sensor Maintenance
14.....	AutoVac Juno Troubleshoot
15.....	Warranty

SAFETY DEFINITIONS

▲ **WARNING:** Indicates a hazardous situation that, if not avoided, could result in death or serious injury.

▲ **CAUTION:** Indicates a hazardous situation that, if not avoided, could result in minor or moderate injury.

▲ **NOTICE:** Indicates a hazardous situation that, if not avoided, could result in property damage.

Before using this product, please read the following safety instructions and follow all safety precautions. Any operation inconsistent with this instruction manual may cause damage to this product.

▲ **WARNING:**

- Your robot is not a toy. Small children and pets should be supervised when your robot is operating.
- Do not sit or stand on your robot.
- Do not use unauthorized chargers. Use of an unauthorized charger could cause the battery to generate heat, smoke, catch fire or explode. Contact customer service for a replacement charger.
- Do not open your robot except as instructed to install or replace the battery or maintain the dustbin and filter(s). Do not open the charging dock as there are no user serviceable parts inside.
- Risk of electric shock. Only use indoors and in dry locations.
- Do not handle your robot with wet hands.
- Store and operate your robot in room temperature environments only.
- Do not operate the robot in areas with exposed electrical outlets in the floor.
- Do not attempt to open, crush or heat the battery of your robot above 175°F.
- Do not subject the battery to mechanical shock.
- Do not short circuit the battery of your robot by allowing any metal objects to contact the battery terminal.
- Do not immerse the battery in liquid.
- Do not attempt to charge damaged or leaking battery packs. If battery leakage occurs, thoroughly wash any affected skin, making sure to keep battery acid away from eyes, ears, nose and mouth. Immediately wash any clothing or other surface that comes in contact with leaked battery acid. If a chemical burn occurs or if irritation persists, seek medical attention. Dispose according to Local, State or Federal regulations.

▲ **CAUTION:**

- If the robot passes over a power cord there is a chance an object can be pulled off a table. Before using the robot, clear the floor of objects such as clothing, cords for blinds and curtains. Power cords and any fragile objects which can be easily damaged.
- Do not use the robot to pick up sharp objects, or anything that is burning or smoking.

▲ NOTICE:

- This robot is intended for dry floor use only. Do not use the robot to pick up any wet spills and do not allow the dustbin contents to become wet.
- Do not place anything on top of your robot
- Regularly wipe charge contacts on your robot and charge dock. Failure to maintain charge contacts could impact the robots ability to properly charge.
- Product may not be used with any type of power converter. Use of power converters will void the warranty.
- The battery pack must be removed from the robot before recycling or disposal.
- Do not use non-rechargeable batteries in your robot. For battery replacement contact customer care.
- Before long term storage of your robot, fully charge and remove the battery.

1: Charging Dock

2: AutoVac Juno

3: Charging Adapter

4: Sidebrush

5: HEPA Filter
(installed)



FRONT

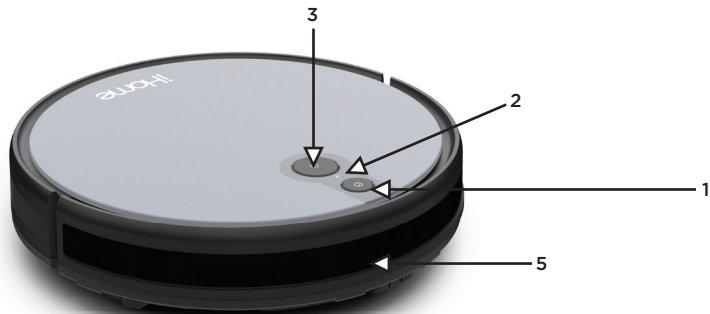

CHARGING BASE

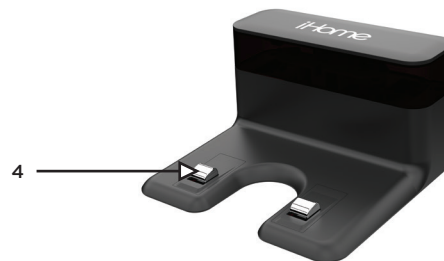

BACK



BOTTOM

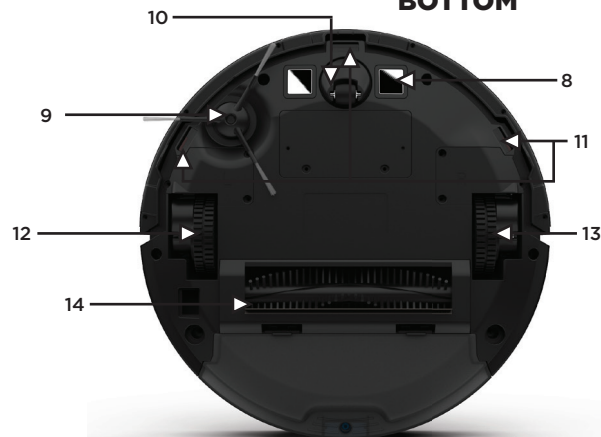

- 1: Power Button
- 2: WiFi Indicator
- 3: Home Button
- 4: Charging Contacts

- 5: Navigation Sensors
- 6: Dustbin Release Latch
- 7: Dustbin
- 8: Charging Contacts

- 9: Side Brush
- 10: Omnidirectional Wheel
- 11: Detection Sensors
- 12: Left Wheel

- 13: Right Wheel
- 14: Main Brush

1: Bin/Filter Release Latch

2: HEPA Filter

3: Screen Filter
(Non removable)

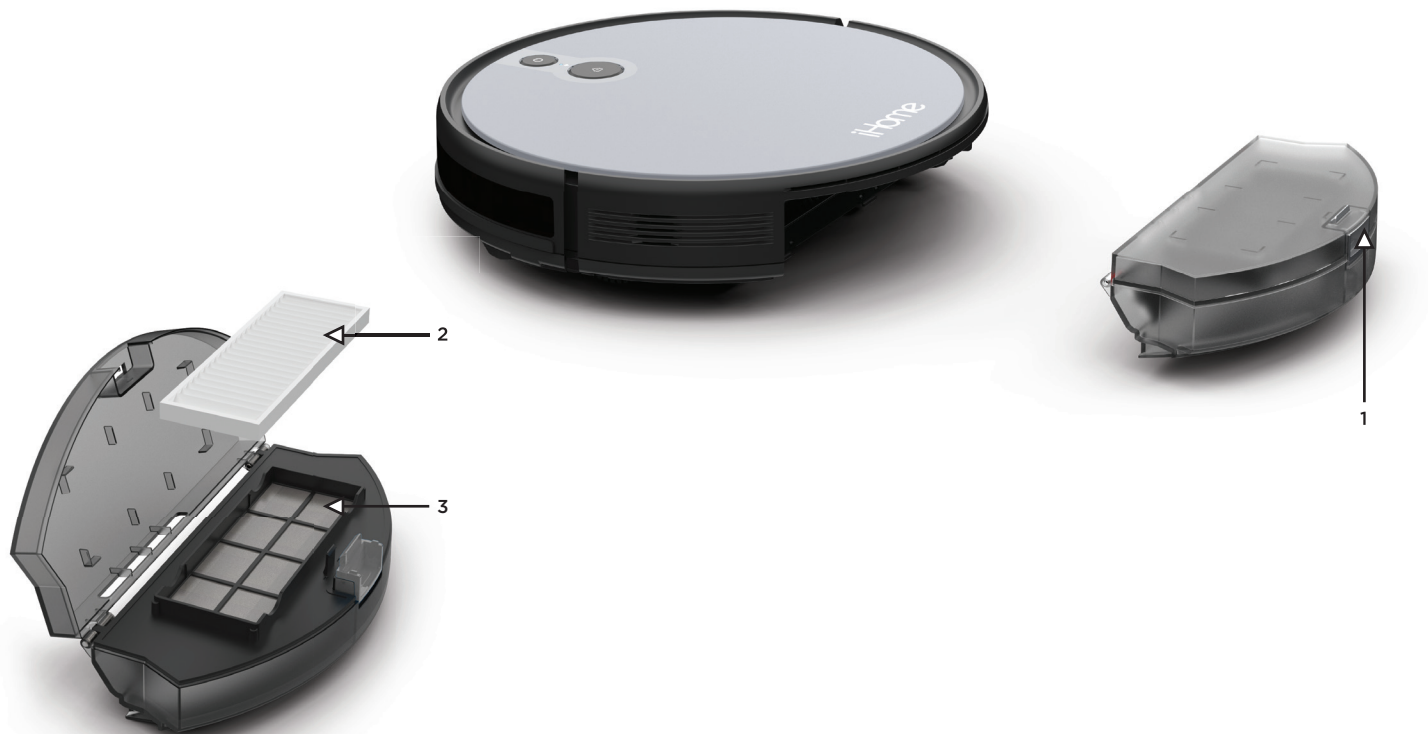

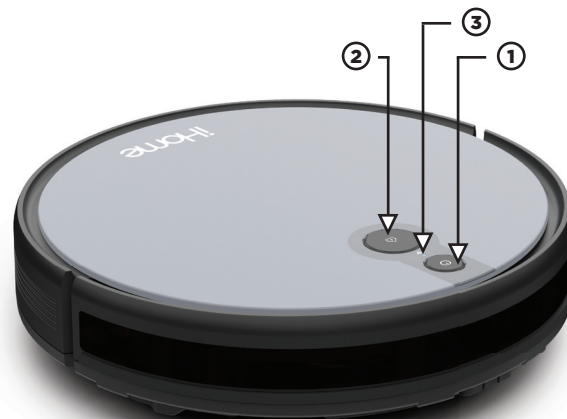
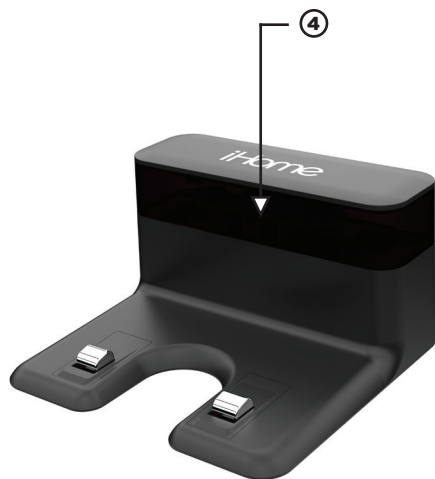

① POWER BUTTON

- Hold to turn on/off
- Press to start/pause cleaning

② HOME BUTTON

- Press to return to charging dock for recharging

③ WIFI INDICATOR

④ CHARGING INDICATOR

POWER/HOME LED STATES

- Blinking Blue: Standby Mode
- Solid Blue (OFF Charge Base): Cleaning
- Solid Green (ON Charge Base): Fully Charged
- Breathing Green: Charging
- Fast Blink Blue: Error
- Lights off: Off/sleeping

WIFI INDICATOR STATES

- Blinking White: Network Configuration Mode
- Solid White: Wifi connected
- Light Off: Wifi disconnected / Network configuration failure

CHARGING INDICATOR LED STATES

- Will remain lit Blue when connected to power

SETTING UP YOUR AUTOVAC JUNO

The following pages outline the complete setup process. For your convenience we created a step-by-step video to help guide you through setup. Please scan the QR code to access the video and other support content.



ABOUT YOUR CHARGING DOCK

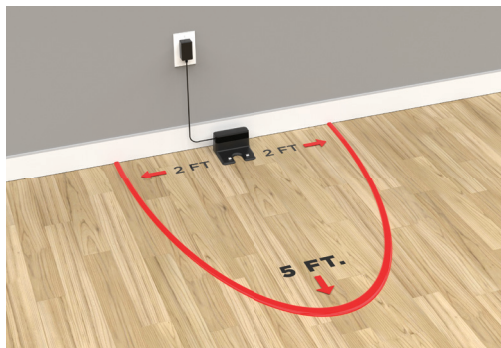

Place the charging dock against the wall and make sure the place is an open & uncluttered area. Leaving at least 5 feet in front of the charging dock and 2 feet on both sides of the charging dock.

NOTE: Clearance around the charging base is necessary to prevent obstructions when the Vacuum returns to charge. Avoid using a power source that may inadvertently be switched off (e.g. power strip, outlet controlled by a light switch, GFCI).

SETTING UP THE CHARGING DOCK

- 1 Plug the power adapter into the port on the bottom of the charging dock and secure the cable into the channel.

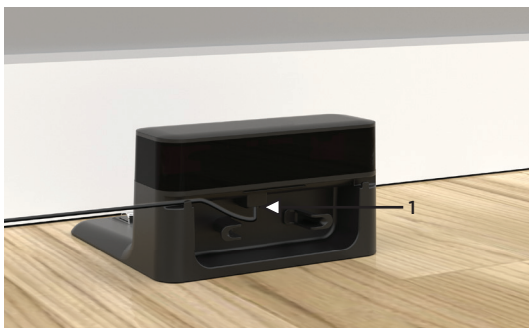

- 2 Choose a location on a hard floor surface near a power outlet. Place the charging dock against the wall as shown. Plug the power adapter into a functioning wall outlet.



STEP 1

Install the side brush by pushing firmly down until it clicks into place.

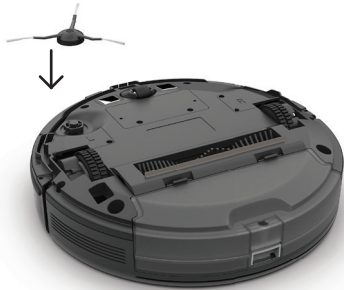

STEP 2

Position the Vacuum on the floor near your charge dock as shown. To turn on Press and Hold the Power button until the indicator turns blue.



NOTE: Allow your Vacuum to fully charge (up to 5 hours) before first use. The indicators on your robot will turn solid green when fully charged.

STEP 3

Now press the  button . The Power and Home icons will slowly fade on/off while charging and turn solid green when fully charged.



UNDERSTANDING YOUR VACUUM

Your iHome AutoVac is designed to automatically and methodically clean your home. Your Vacuum uses multiple sensors to clean your home efficiently, row by row. Cleaning history is available to view in the Home app. Once cleaning is finished or the battery is low, the Vacuum will automatically return to the charge dock.

DOWNLOAD THE IHOME CLEAN APP

- Search “iHome Clean” in the App Store or use the QR code below:



NOTE: Connecting your Vacuum to Wi-Fi is not required but highly recommended. Using the Home app, you can follow the steps to connect your Vacuum to Wi-Fi. The app will let you manage your Vacuum from anywhere, set cleaning schedules, view cleaning history, access support and more!

The iHome Clean app provides an easy step by step guide to get your Vacuum connected to Wi-Fi. Here is a checklist of what you'll need before getting started:

- An iPhone (iOS 10 or later) OR Android (4.4 or later).
- Make sure that your phone is connected to your desired Wi-Fi Network. This will be the network that your AutoVac Juno connects to.
- Your Wi-Fi network must be a 2.4Ghz network (5Ghz networks are not supported).
- Download and launch the iHome Clean app from the app store. Create a user account.
- Follow the steps in the app to add the Vacuum.

For your convenience we've created a video to walk through the App Setup process. Scan the QR code below to watch.



▲ CAUTION:

- Power off the vacuum before performing maintenance.

Your Vacuum is designed to be used regularly. As with most floor care devices, regular use may cause build-up around brushes, in debris compartments and near filters. We recommend performing regular maintenance, as outlined in the following pages, to keep your AutoVac Juno running at optimal performance.

1: Pinch the left and right tabs on the main brush cover. Lift and remove the cover.

2: Remove the main brush and clean.

3: Replace the main brush and snap the cover back into place.

NOTE: It is recommended to replace the main brush every 6-12 months depending on use.

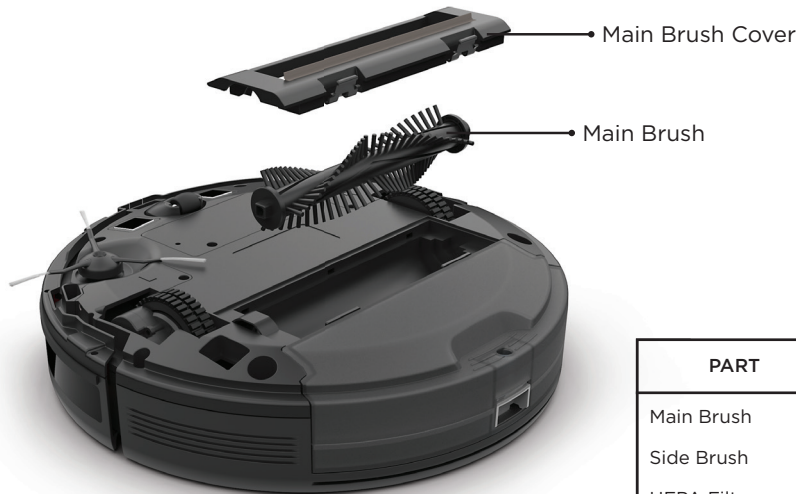

MAINTENANCE SCHEDULE

PART	CARE FREQUENCY	REPLACEMENT FREQUENCY
Main Brush	Once a month	Replace every 6-12 months
Side Brush	Once a month	Replace every 6-12 months
HEPA Filter	Every 2 Weeks	Replace every 3 months

- 1 Press the dustbin release button and remove the dustbin.



- 2 Empty the dustbin contents into the trash and wipe the inside thoroughly with a dry cloth.

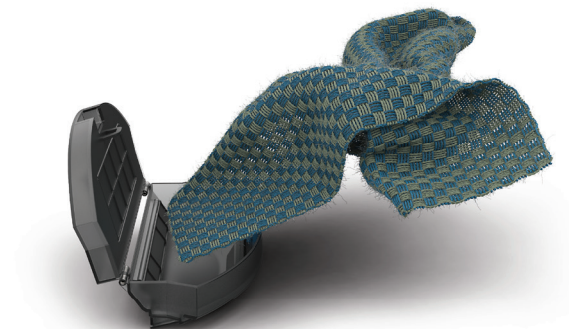

- 3 To access the HEPA filter pull up on the filter housing tab. Remove the HEPA filter and dislodge any dust or debris. Rinse the primary filter screen with water and wipe dry completely before reassembly.

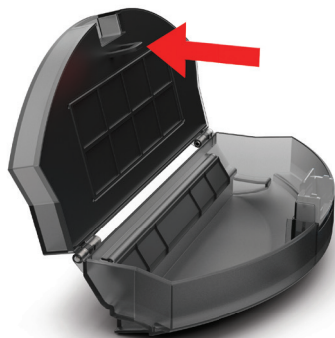

- 4 Remove the HEPA filter, wipe down the surface with a dry cloth. Rinse the primary filter with water and let dry completely before using.

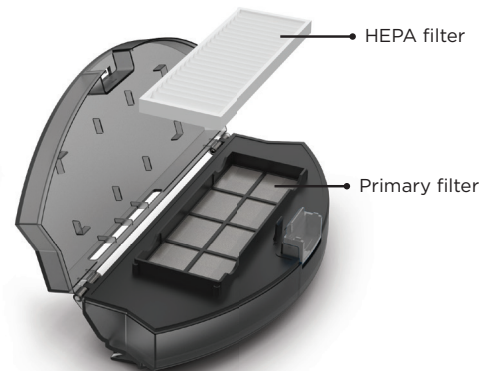

- 1: Pop off the side brush by pulling it upward.
- 2: Remove dirt and debris and reinstall by pushing down in place.
- 3: It is recommended to wipe dust from the charging pins on your robot and charge dock regularly.

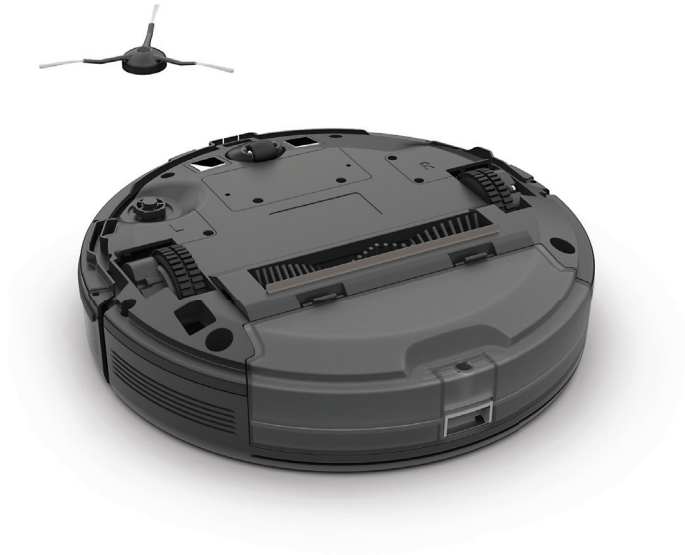

NOTE: It is recommended to replace the side brush every 6-12 months depending on use.

PROBLEM

SOLUTION

Unable to power on	Please charge before use. This is commonly caused due to low battery.
Unable to start cleaning	Please charge before use. This is commonly caused due to low battery.
Unable to return to charging dock	<ul style="list-style-type: none"> • There are too many obstacles near the charging dock. Please make sure there is a clear area 2 FT of space on either side and 5 FT in front of the charging dock. • Vacuum is out of range of the charging dock. Move the Vacuum closer to the charging dock to re-establish connection.
Abnormal behavior	Please make sure the areas to be cleaned are well illuminated. Clean the lens with a clean soft cloth, and make sure the sensor is not blocked. Avoid using any detergent or cleaning spray while cleaning.
Abnormal noise during cleaning	Main brush, side brush or left/right wheel may be obstructed, Check underneath the Vacuum to make sure it is clear from any obstruction. If there is an obstruction clear it and restart the Vacuum.
Decrease in cleaning ability or dust falling out from dustbin	<ul style="list-style-type: none"> • The dustbin is full, please empty the dustbin. • Check and clean the HEPA filter. • Check that the brush is clear from obstruction.
Unable to connect to Wi-Fi	Wi-Fi signal is not good , please check that there is a strong Wi-Fi connection while paring. Make sure the network is 2.4G and not 5G or dual band.
Vacuum is not returning to the charging dock after spot cleaning or after moving it far from the charging dock	After spot cleaning or moving the Vacuum far from the charging dock the Vacuum will re-generate the map. If the Vacuum is far from the charging dock it may not be able to locate it. Please manually dock the Vacuum to the charging dock to recharge.
Unable to charge after docking	Make sure there is no obstruction or heavy dust on both the Vacuum and charging dock charging contacts.
Scheduled cleaning not working	Please confirm that the Vacuum is connected to your Wi-Fi network. If the Vacuum is not connected to the network you cannot synchronize the scheduled cleaning task.

The One (1) Year Limited Warranty applies to purchases made from authorized retailers of Silver Point Innovations LLC. Warranty coverage applies to the original owner and to the original product only and is not transferable. We recommend registering your product online at www.ihomeclean.com

SilverPoint warrants this product to be free from defects in workmanship and materials, under normal household use and conditions, one (1) year from the date of original purchase and maintained according to the requirements outlined in this User Manual. Should this product fail to function in a satisfactory manner, it is best to contact our customer service team at 877-370-4580 so that we may help resolve the matter. Should service be required by reason of any defect or malfunction during the warranty period, SilverPoint will repair or, at its discretion, replace the product

The One (1) Year Limited Warranty is subject to the following conditions and exclusions:

The original unit and/or non-wearable parts deemed defective, in SilverPoint's sole discretion, will be repaired or replaced up to one (1) year from the original purchase date. In the event a replacement unit is issued the replacement product will be warranted for the remainder of the original warranty period or thirty (30) days from the date of shipment of the replacement product, whichever is longer. SilverPoint reserves the right to use new, refurbished or used parts in good working condition to repair or replace any product.

Exclusions:

- (1) Normal wear and tear of wearable parts (such as batteries, brushes, HEPA filters, pads, etc.), which require regular maintenance and/or replacement to ensure the proper functioning of your unit, are not covered by this warranty. Replacement parts are available for purchase at www.ihomeclean.com.
- (2) Any unit that has been tampered with or used for commercial purposes.
- (3) Damage caused by misuse, abuse, negligent handling, failure to perform regular maintenance (i.e., not cleaning the filters), or damage due to mishandling in transit.
- (4) Consequential and incidental damages.
- (5) Defects caused by repair persons not authorized by SilverPoint.
- (6) Products purchased, used, or operated outside of North America.

Warranty Support:

You must call 877-370-4580 to initiate a warranty claim and have the product on hand during the call. You will need the original receipt as proof of purchase.

The One (1) Year Limited Warranty does not cover the cost of shipping this product to our service center or its return to the owner. Please call Customer Service at 877-370-4580 to evaluate your product and receive warranty term instructions.

Disclaimer: This warranty is valid only in the United States of America and does not extend to owners of the product other than to the original purchaser. In no event will SilverPoint or any of its affiliates, contractors, resellers, their officers, directors, shareholders, members or agents be liable to you or any third party for any consequential or incidental damages, any lost profits, actual, exemplary or punitive damages. (Some states do not allow limitations on implied warranties or exclusion of consequential damages, so these restrictions may not apply to you.) This warranty gives you specific legal rights, and you may also have other rights which vary from state to state. Your acknowledgement and agreement to fully and completely abide by this disclaimer of warranty is contractually binding to you upon your transfer of currency (money order, cashier's check, or credit card) for purchase of your SilverPoint product.