

EAGLE



OPERATION MANUAL
H1-EGE

HELMETS SAVE LIVES!

Always wear a properly fitted helmet that complies with CPSC or CE safety standards when you ride your scooter.

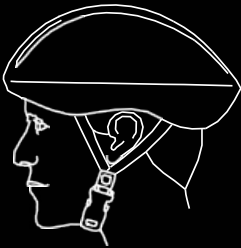

Correct Fitting:

Make sure your helmet covers your forehead.

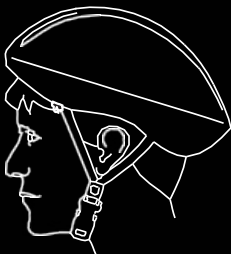

Incorrect Fitting:

Forehead is exposed and vulnerable to serious injury.

WARNING

As with all mechanical components, the Hover-1 Eagle is subjected to wear and high stresses. Different materials and components may react to wear or fatigue in different ways. If the design life of a component has been exceeded, it may suddenly fail possibly causing injuries to the rider. Any form of crack, scratch or change of coloring in highly stressed areas indicate that the life of the component has been reached and it should be replaced. Do not ride in an abusive manner.

CAUTION

In this manual, the CAUTION sign indicates a hazardous situation which, if not avoided, can cause minor or moderate injury.

WARNING

In this manual, the WARNING sign indicates a hazardous situation which, if not avoided, can cause death or serious injury.

WARNING

Great care should be taken with the Hover-1 Eagle when folding or unfolding. If you do not understand how to operate the levers, please visit www.Hover-1.com

DO NOT RIDE YOUR HOVER-1 EAGLE WITHOUT ALL RELEASES SECURELY LOCKED.

WARNING!

PLEASE READ THE USER MANUAL THOROUGHLY.

Failure to follow the basic instructions and safety precautions listed in the user manual can lead to damage to your device, other property damage, serious bodily injury, and even death.

Thank you for purchasing the Hover-1 Eagle. Please read all instructions carefully before using and retain this manual for future use and reference.

This manual applies to the Hover-1 Eagle.

- In order to avoid dangers that are caused by collisions, falls, and loss of control, please learn how to ride the Eagle safely.
- You can learn operating skills by reading the product manual and watching videos.
- This manual includes operating instructions and precautions. Users must read it carefully and follow the instructions.
- All users are responsible for any consequences caused by violating warning contents or prompt operations. Hover-1 can not be held liable.

ATTENTION

1. Use only the supplied charger with this scooter.

Charger Manufacturer: SHENZHEN HYLETON TECHNOLOGY Co., LTD

Model: HLT-118C-4201000

2. The operating temperature range of the charger is $-4 - 140^{\circ}\text{F}$ ($-20 - 60^{\circ}\text{C}$).
3. The operating temperature range of the E-Scooter is $32 - 104^{\circ}\text{F}$ ($0 - 40^{\circ}\text{C}$).
4. Do not ride on icy or slippery surfaces
5. Read the operation manual and warning labels before riding.
6. Store the Eagle in a dry, ventilated environment.
7. When transporting the Eagle, avoid violent crashes or impact.

LOW TEMPERATURE WARNING

Low temperature will affect the lubrication of moving parts inside the Eagle, increasing internal resistance. At the same time, in low temperatures, the discharge capacity and the capacity itself of the battery will be significantly decreased.

Use caution when riding the Eagle in cold temperatures (below 40 degrees F).

Doing so may increase the risk of mechanical failures of the scooter, which may lead to damage to your device, other property damage, serious bodily injury and even death.

SAFETY INSTRUCTIONS

- Keep the device away from heat sources, direct sunlight, humidity, water and any other liquids.
- Do not operate the device if it has been exposed to water, moisture or any other liquids to prevent against electric shock, explosion and/or injury to yourself and damage to the device.
- Do not use the device if it has been dropped or damaged in any way.
- Repairs to electrical equipment should only be performed by the manufacturer. Improper repair voids the warranty and may place the user at serious risk.
- Do not puncture or harm the exterior surface of the product in any way.
- Keep the device free from dust, lint, etc.
- Do not use this device for anything other than its intended use or purpose. Doing so may damage the device or lead to property damage, injury or death.
- This product is not a toy. Keep out of reach of children.
- Do not expose batteries, battery pack, or batteries installed to excessive heat, such as direct sunlight, or open flame.
- Do not allow hands, feet, hair, body parts, clothing or similar articles to come in contact with moving parts, wheels or drive-train, while the Eagle is running.

- Do not operate, or allow others to operate, the Hover-1 Eagle, until the user understands all instructions, warnings and safety features described in this manual.
- Check with your doctor if you have a medical condition that could affect your ability to use the Hover-1 Eagle.
- Persons with head, back or neck ailments or prior surgeries to those areas of the body are not recommended to use this Hover-1 Eagle.
- Do not operate if you are pregnant, have a heart condition, or have both.
- Persons with any mental or physical conditions that may make them susceptible to injury or impair their physical or mental capabilities to recognize, understand and perform all of the safety instructions and to be able to assume the hazards inherent in unit use, should not use the Hover-1 Eagle.



NOTES:

In this manual, the above symbol with the word "NOTES" indicates instructions or relevant facts the user should remember prior to using the device.



CAUTION!

In this manual, the above symbol with the word "CAUTION" indicates a hazardous situation which, if not avoided, can cause minor or moderate injury.



WARNING!

In this manual, the above symbol with the word "WARNING" indicates a hazardous situation which, if not avoided, can cause death or serious injury.

SERIAL NUMBER

Please keep the serial number on file for warranty claims as well as proof of purchase.



WARNING!

WARNING: Prolonged exposure to UV rays, rain and the elements may damage the enclosure materials. Store indoors when not in use.

INTRODUCTION

This manual is designed to give you the information you need for the safe operation and maintenance of your new Eagle scooter. Please read it thoroughly before riding your Eagle.

WARNING

Make sure you read this complete manual before riding your Hover-1 Eagle. Failure to do so, or failure to follow its guidelines could lead to serious injury or death.

The Eagle is a personal transporter. Our technology and production processes are developed with strict testing for each Eagle scooter. Operating the Eagle without following the contents of this manual may lead to damage to your Eagle scooter, or bodily injury.

PACKAGE CONTENTS

- Hover-1 Eagle Electric Folding Scooter
- Wall Charger
- Operation Manual

Your Hover-1 Eagle's serial number is stamped respectively on the kickstand side of the platform. Record the serial number in the designated area of the "WARRANTY" section of this manual in the event that your Hover-1 Eagle is lost or stolen.

SAFETY PRECAUTIONS

- The first rule in safe riding is to use common sense.
- Different localities and countries have different laws governing riding electric transportation devices on public roads.
- You should check with local officials to ensure you are complying with local traffic law requirements.
- Hover-1 is not liable for tickets or violations given to riders who do not follow local laws and regulations.
- For your safety, always wear a helmet that meets CPSC or CE safety standards. In the event of an accident, a helmet can protect you from serious injury and in some cases, even death.

- Obey all local traffic laws. Obey red and green lights, one-way streets, stop signs, pedestrian crosswalks, etc.
- Ride with the traffic, not against it.
- Ride defensively; expect the unexpected.
- Give pedestrians the right-of-way.
- Do not ride too close to pedestrians and alert them if you intend to pass them from behind.
- Slow down at all street intersections and look to the left and right before crossing.

Your Eagle electric folding scooter is not equipped with reflectors. It is not recommended that you ride in conditions of low visibility.

If you are riding your scooter in low-visibility conditions, ensure your LED light is turned on, and that you are wearing bright, reflective clothing.

WARNING

When you ride in low-visibility conditions such as fog, dusk, or night, you might be difficult to see, which could lead to a collision. To increase your level of safety, be sure wear bright, reflective clothing when riding in poor lighting conditions.

Think about safety when you ride. You can prevent many accidents if you think about safety. Below is a helpful checklist for riders.

SAFETY CHECKLIST

- Do not ride above your skill level. Ensure you have had enough practice with all functions and features of your Eagle.
- Do not ride too fast – with increased speed comes increased risk. If you are moving at a higher speed, small bumps can turn into large impacts, leading to a higher risk of injury if an accident occurs.
- Do not ride with pets.
- Before stepping on your Eagle, make sure it is placed flat on level ground and the power is on.

- Do not try to open or modify your Eagle scooter. Doing so, voids the manufacturer warranty and may cause your Eagle to fail, resulting in injury or death.
- Do not use the Eagle in a manner that would put people or property in danger.
- If you and your friend(s) are riding Eagle scooters together, be sure to keep a safe distance between each other to prevent collisions, property damage, serious injuries or even death.
- Be sure to keep your feet on the scooter at all times. Moving your feet off your scooter while driving is dangerous and may cause the scooter to stop or veer sideways.
- Do not operate the Eagle while under the influence of drugs and/or alcohol.
- Do not operate the Eagle when you are restless or sleepy.
- Use your best judgment to keep yourself out of dangerous situations with your Eagle.
- Do not ride your Eagle scooter off of curbs, ramps, or attempt to operate in a skate park, empty pool, or in any way similar to a skateboard. Misuse of your Eagle, voids the manufacturer warranty and may lead to injury or damage.
- Do not abuse your Eagle, doing so can damage your unit and cause failure to the operating system which may lead to injury. Physical abuse, including dropping your Eagle scooter, voids the manufacturer warranty.
- Do not operate in or near puddles of water, mud, sand, stones, gravel, debris or near rough and rugged terrain.
- The Eagle can be used on paved surfaces that are flat and even. If you encounter uneven pavement, please lift your Eagle scooter over and past the obstruction.
- Do not ride in inclement weather: snow, rain, hail, sleet, on icy roads or in extreme heat or cold.
- Bend your knees when riding on bumpy or uneven pavement to absorb the shock and vibration and help you keep your balance.
- If you are unsure if you can safely ride on a specific terrain, step off



WARNING

Proper use of your brake is vital to ensure safe, efficient stopping. To avoid misuse and potential injury, do not apply sudden or excessive force to your brakes. Apply your brakes gradually and give yourself enough room to come to a complete stop safely.

and carry your Eagle. ALWAYS BE ON THE SIDE OF CAUTION.

- Do not attempt to ride over bumps or objects greater than ½ in. even when prepared and bending your knees.
- PAY ATTENTION - look at where you are riding and be conscious of the road conditions, people, places, property and objects around you.
- Do not operate the Eagle scooter in crowded areas.
- Operate your Eagle scooter with extreme caution when indoors, especially around people, property, and narrow spaces.
- Do not operate the Eagle while talking, texting, or looking at your phone.
- Do not ride your Eagle scooter where it is not permitted.
- Do not ride your Eagle near motor vehicles or on public roads.
- Do not travel up or down steep hills.
- The Eagle is intended for use by a single individual, DO NOT attempt to operate the Eagle with two or more people.
- Do not carry anything while riding the Eagle scooter.
- Individuals with lack of balance should not attempt to operate the Eagle scooter.
- Pregnant women should not operate the Eagle scooter.
- Young children and the elderly should not operate the Eagle.
- At higher speeds, always take into consideration longer stopping distances.
- Do not attempt to jump on or off your Eagle scooter.

WARNING

When you ride in low-visibility conditions such as fog, dusk, or night, you might be difficult to see, which could lead to a collision. In addition wear bright, reflective clothing when riding in poor lighting conditions.

- Do not attempt any stunts or tricks with your Eagle scooter.
- Do not ride the Eagle in dark or poorly lit areas.
- Do not ride the Eagle near or over potholes, cracks or uneven pavement or surfaces.
- Do not operate your Eagle scooter off-road.
- Do not turn sharply, especially at high speeds.
- Do not exceed the maximum or minimum weight limits.
- Avoid driving the Eagle in unsafe places, including near areas with flammable gas, steam, liquid, dust, fiber, which could cause fire and explosion accidents.
- Do not operate near swimming pools or other bodies of water.

WARNING

There may be additional risk to injury if you use your scooter incorrectly. This includes, but is not limited to:

- Jumping your scooter
- Riding over debris or obstacles
- Performing stunts
- Riding in off-road terrain
- Riding fast
- Racing other riders
- Riding in unusual manner

The aforementioned examples add stress to each part of your scooter and can lead to long term damage of the device. Damage to your scooter can lead to an accident or increase your risk of injury. To decrease your risk of injury, use your scooter correctly.

WARNING

To reduce the risk of injury, adult supervision is required. Never use in roadways, near motor vehicles, on or near steep inclines or steps, swimming pools or other bodies of water; always wear shoes, and never allow more than one rider.

WARNING

To reduce the risk of injury, adult supervision is required. Never use in roadways, near motor vehicles, on or near steep inclines or steps, swimming pools or other bodies of water; always wear shoes, and never allow more than one rider.

CARE & MAINTENANCE

- Do not expose the device to liquid, moisture, or humidity to avoid damage to the product's internal circuitry.
- Do not use abrasive cleaning solvents to clean the device.
- Do not expose the device to extremely high or low temperatures as this will shorten the life of the electronic device, destroy the battery, and/or distort certain plastic parts.
- Do not dispose of the device in fire as it may explode or combust.
- Do not expose the device to contact with sharp objects as this will cause scratches and damage.
- Do not let the device fall from high places, as doing so may damage the internal circuitry.
- Do not attempt to disassemble the device.
- Use only the charger provided by Hover-1.

WARNING

Avoid using water or other liquids for cleaning. If water or other liquids enter the Eagle, it will cause permanent damage to the internal components.

WARNING

Users who disassemble the Eagle scooter without permission will void the warranty.

BATTERY CARE / MAINTENANCE

BATTERY SPECIFICATIONS

Battery Type: Rechargeable lithium-ion battery

Charge Time: Up to 5 hours

Battery Voltage: 36V

Battery Capacity: 4 Ah

Working Temperature: -4°F - 140°F

Charging Temperature: 32°F - 104°F

Storage Time: 1 year

Storage Temperature: -4°F - 104°F

Storage Humidity: 5% - 95%

BATTERY MAINTENANCE

The lithium-ion battery is built into the device. Do not disassemble the device to remove the battery or attempt to separate it from the device.

- When charging the device, please use the enclosed 1-pin charging cable or otherwise ensure that the battery charging conditions are met.
- Do not connect or attach the device or the battery to a power supply plug or directly to a car's cigarette lighter.
- Do not place the device or batteries near a fire, or into direct sunlight. Heating the device and/or the battery can cause additional heating, breaking, or ignition of the battery inside the device.
- Do not continue charging the battery if it does not recharge within the specified charging time. Doing so may cause the battery to become hot, rupture, or ignite.

To preserve natural resources, please recycle or dispose of batteries properly. This product contains lithium-ion batteries. Local, state, or federal laws may prohibit disposal of lithium-ion batteries in ordinary trash. Consult your local waste authority for information regarding available recycling and/or disposal options.

WARNING

Failure to follow the safety precautions listed below could lead to serious bodily injury and/or death.

- Do not attempt to modify, change, or replace your battery.
- Do not use your device if the battery begins to emit odor, overheats, or begins to leak.
- Do not touch any leaking materials or breathe fumes emitted.
- Do not allow children and animals to touch the battery.
- The battery contains dangerous substances, do not open the battery, or insert anything into the battery.
- Please only use the charger provided by Hover-1.
- Do not attempt to charge the device if the battery has discharge or emits any substances. In that case, immediately distance yourself from the battery in case of fire or explosion.
- Lithium-ion batteries are considered to be hazardous materials. Please follow all local, state and federal laws in regards to recycling, handling and disposing of Lithium-ion batteries.

 **WARNING**

SEEK IMMEDIATE MEDICAL ASSISTANCE IF
YOU ARE EXPOSED TO ANY SUBSTANCE
THAT IS EMITTED FROM THE BATTERY.

SPECIFICATIONS

Model:	H1-EGE
Net Weight:	20.88 lbs (9.47 kg)
Max Supported Weight:	264 lbs (120 kg)
Min Supported Weight:	44 lbs (20 kg)
Max Speed:	Up to 15 mph (24km/h)
Max Distance Range:	Up to 7 miles (11.2 km)
Battery Type:	Lithium-ion
Motor Power:	320W Brushless Motor
Battery Voltage:	36 V
Battery Capacity:	4.0 Ah
Power Requirement:	AC 100-240V, 50/60 Hz
Folding Size:	(38.5 in. x 15.7in. x 16.5in.) (97.8cm x 40 cm x 42 cm)
Open Size:	(38.5 in. x 15.7 in. x 44.7in.) (97.8 cm x 40cm x 113.5 cm)
Tire Type:	Non-Pneumatic Solid Tires
Tire Size:	6.5" Front & Rear
Brake Type:	Electronic & Mechanical Brakes

PARTS LIST

A. Scooter

B. Handle Bars

C. Wall Charger

D. Allen Wrench

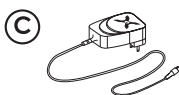
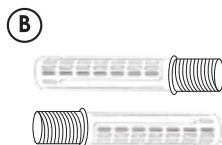
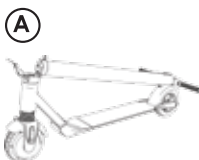

HOVER-1 EAGLE DIAGRAM

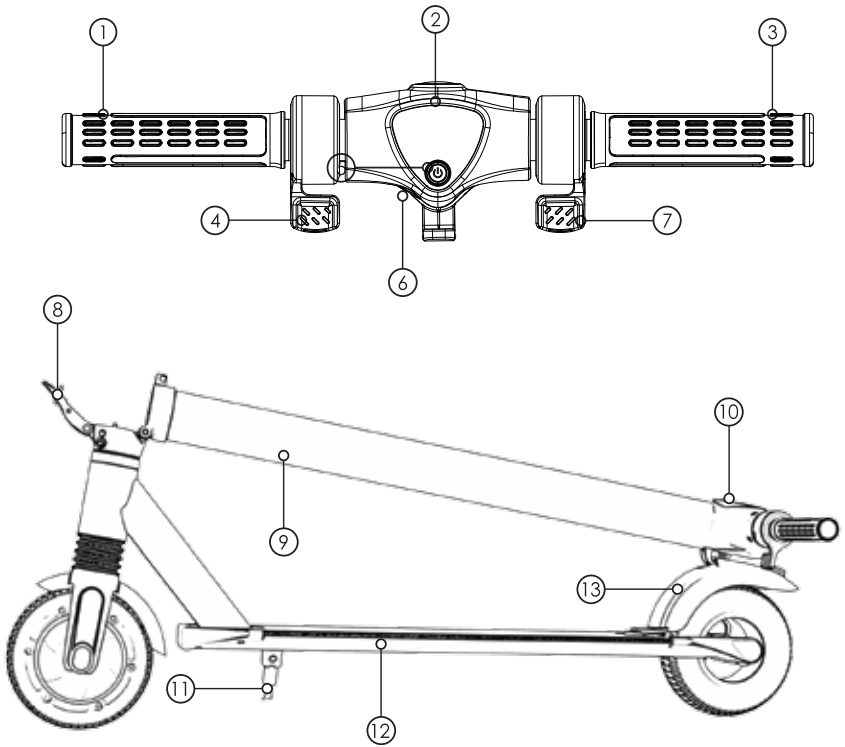

FEATURES/PARTS

- | | |
|--------------------------|----------------------|
| 1. Handlebars(L) | 8. Release Lever |
| 2. LCD Display | 9. Aluminum Frame |
| 3. Handlebars(R) | 10. LED Light |
| 4. Electric Brake | 11. Kickstand |
| 5. Power/Function Button | 12. Foot Pad |
| 6. Charging Port | 13. Mechanical Brake |
| 7. Throttle | |

HOVER-1 EAGLE DIAGRAM



LCD DISPLAY

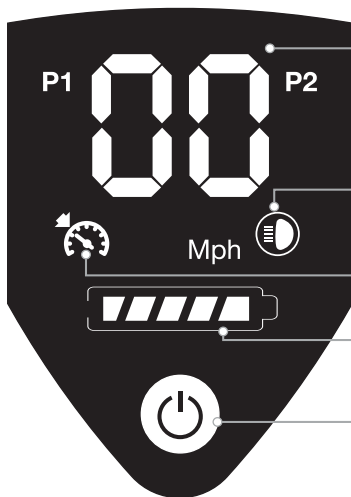

SPEEDOMETER

Displays your current speed in Mph.

Displays the current speed Level:
Ensure it is powered on, press once to switch high speed / low speed mode:
P1 - Low speed
P2- High speed

HEADLIGHT ICON

Indicates the headlight is activated.

CRUISE CONTROL ICON

Indicates the cruise control is activated.

BATTERY INDICATOR

Displays your current battery life.

POWER/ FUNCTION BUTTON

Press and hold 3 seconds to power ON.
Once the scooter display is on, Press twice to turn on headlights, then press twice to turn off headlights.

CHARGING YOUR EAGLE

CHARGING THE DEVICE

- Ensure that the charging port is clean and dry.
- Make sure that there is no dust, debris or dirt inside the port.
- Plug the charger into a grounded wall outlet.
- Connect the cable with the power supply (100V ~ 240V; 50/60 Hz).
- Align and connect the 1-pin charging cable into the charging port of the Eagle Scooter.

(DO NOT FORCE OR BEND THE CHARGING CABLE AS IT MAY CAUSE THE PRONGS TO BEND OR BREAK.)

- The charging indicator light on the charger itself should change to RED, indicating that your device is now being charged.
- When the RED indicator light on your charger turns to GREEN, then your device is fully charged.
- After fully charging your Eagle Scooter, unplug the charger from your device and from the power outlet.

CAUTION

Only use the included charging cable and charger to charge your Hover-1 Eagle. Using any other unauthorized charger may damage your Hover-1 Eagle.

WARNING

Any Eagle that does not work properly can cause you to lose control and fall. Inspect the entire device thoroughly before every ride, and do not ride it until any problems have been corrected.

PREPARING YOUR SCOOTER

PLEASE READ THE FOLLOWING INSTRUCTIONS CAREFULLY

ATTACHING THE HANDLEBARS

Attach the handle bars by placing them into the appropriate sockets and twisting them in the correct direction.



NOTE: If the handlebars do not attach flush to the frame, you may need to shift the location of your throttle and brake assembly appropriately. Tighten or loosen the throttle and brake assembly with the included hex key and make sure they are NOT touching or blocking your handlebars.

PINCH POINTS

Some parts of your Hover-1 Eagle can injure you if mishandled. Moving and folding parts can cut skin. Clamps and pivoting parts such as brake levers can pinch. When folding and unfolding your Hover-1 Eagle, Please watch for pinch points where possible injury may be sustained. Do not leave your hand in these areas during folding or unfolding.



FOLDING & UNFOLDING

FOLDING & UNFOLDING YOUR EAGLE SCOOTER.

To unfold your Eagle, press the blue button on the release lever and pull the lever. Lower the steering column into the folded position. Press the folding clip into the top of the foot brake until you hear a click. Press the foot brake to release the folding hinge. Always make sure the lever is secure before riding your Eagle scooter.



PRESS THE BLUE RELEASE LEVER BUTTON TO UNLOCK AND PULL THE LEVER

HIGH SPEED MODE

To active high speed mode, ensure the Eagle is powered on and not in motion. Press the power button twice. The high speed mode indicator should light up on your display to indicate it is activated.

CRUISE CONTROL

To activate cruise control, you must hold the throttle at a constant speed above 3 mph for 5 seconds. For example, if you want to activate cruise control at 10 mph, hold the throttle at 10 mph for 5 seconds. You will hear a beep and the cruise control indicator will light up on the LCD display indicating that it is activated.

BEFORE RIDING

WARNING

Any Eagle Scooter that does not work properly can cause you to lose control and fall. Do not ride an Eagle with a part that is damaged; replace the damaged part before riding.

It is important that you fully understand all elements of your Eagle scooter. If these elements are not used correctly, you will not have full control of your Eagle. Before you ride, learn the functions of the various mechanisms on your scooter.

Practice using these elements of your Eagle at slower speeds in a flat, open area before taking the device out in public areas.

PRE-RIDE CHECKLIST

Ensure that your Eagle is in proper working order each and every time you ride. If a part of the Eagle scooter does not function correctly, please contact our Customer Support Center.

- Ensure the battery is fully charged before riding your scooter.
- If the Eagle scooter is not used for an extended period of time, you may need to recharge the battery every 2 months to maintain the battery life.
- Please wear all appropriate safety and protective gear as previously mentioned in the User Manual before operating your device.
- Make sure to wear comfortable clothes and flat closed-toe shoes when operating your device.
- Please carefully read the Operation Manual, which will assist in explaining the basic working principles and provide tips on how to best enjoy your experience.

RIDING YOUR EAGLE SCOOTER

FAILURE TO FOLLOW ANY OF THE FOLLOWING SAFETY PRECAUTIONS CAN AND MAY LEAD TO DAMAGE TO YOUR DEVICE, VOID YOUR MANUFACTURER WARRANTY, LEAD TO PROPERTY DAMAGE, CAUSE SERIOUS BODILY INJURY, AND CAN LEAD TO DEATH.

OPERATING YOUR DEVICE

Make sure the device is fully charged before the first initial use. Before turning on your Eagle scooter, ride it like a normal kick scooter to get comfortable with the device before using it with the motor.

When comfortable riding the scooter, power it on. For the motor to activate, you must first start riding the scooter and then push the throttle down with your thumb.

To slow down the scooter, push the electric brake down. This will stop the motor and slow you down. Also press the mechanical brake with your foot to manually slow down the scooter.

To turn, use the handlebar to turn in the direction you wish to turn.

The Eagle scooter can be operated manually if you do not wish to use the motor.

As you get comfortable on the device, you will notice it becomes easier to maneuver. Remember at higher speeds, it is necessary to shift your weight to overcome the centrifugal force.

Prepare to brace yourself if you encounter bumps or uneven surfaces, then dismount and carry your Eagle to a safe operating surface.



WARNING

Do not turn sharply or at high speeds to avoid danger. Do not turn or ride quickly along slopes, as it may cause injury.

WEIGHT AND SPEED LIMITATIONS

Speed and weight limits are set for your own safety. Please do not exceed the limits listed in the "Specifications" section of this manual.

WARNING

Overweight exertion on the device may increase possibility of injury or product damage.

OPERATING RANGE

The following are some of the major factors that will affect the operating range of your device.

- **Terrain:** Riding distance is highest when riding on a smooth, flat surface. Riding uphill and/or on rough terrain will reduce distance significantly.
- **Weight:** A lighter user will have further range than a heavier user.
- **Ambient temperature:** Please ride and store the device under recommended temperatures, which will increase driving distance; battery life, and overall performance of your device.
- **Speed and Riding Style:** Maintaining a moderate and consistent speed while riding produces maximum distance. Traveling at high speeds for extended periods, frequent starts and stops, idling and frequent acceleration or deceleration will decrease overall distance.

*Do not attempt to stop suddenly as this may lead to injury or damage to your brake discs.

WARNING

Proper use of your brake is vital to ensure safe, efficient stopping. To avoid misuse and potential injury, do not apply sudden or excessive force to your brake. Apply the brake gradually and give yourself enough room to come to a complete stop safely.

Please follow all local, state and federal laws in regards to recycling, handling and disposing of Lithium-ion Battery.

WARNING

SEEK IMMEDIATE MEDICAL ASSISTANCE
IF YOU ARE EXPOSED TO ANY
SUBSTANCE THAT IS EMITTED FROM
THE BATTERY.

SAFETY ALERTS

While riding your Eagle Scooter, if there is a system error or illegal operation performed the device will prompt the user in a variety of ways.

The following are common occurrences where you will see Safety Alerts. These notices should not be ignored, but appropriate action should be taken to correct any illegal operation, failure or errors.

- Prohibited riding surfaces (uneven, too steep, unsafe, etc.)
- Battery voltage is too low.
- The device is still charging.
- Overheating, or motor temperature is too high.
- When the battery is about to run out of power, the battery icon will flash.
- If any or both tires are blocked, the device will stop after 10 seconds.
- When the battery level has depleted below protection mode, the device motor will power off after 15 seconds.

While sustaining a high discharge current during use (such as riding up a steep slope for a long period of time), the device motor will power off after 15 seconds.

FCC STATEMENT

This device complies with part 15 of the FCC Rules. Operation is subject to the following two conditions: (1) This device may not cause harmful interference, and (2) this device must accept any interference received, including interference that may cause undesired operation.

Please note that changes or modifications not expressly approved by the party responsible for compliance could void the user's authority to operate the equipment.

FCC INSTRUCTIONS FOR A CLASS B DIGITAL DEVICE OR PERIPHERAL

Note: This equipment has been tested and found to comply with the limits for a Class B digital device, pursuant to part 15 of the FCC Rules. These limits are designed to provide reasonable protection against harmful interference in a residential installation. This equipment generates, uses and can radiate radio frequency energy and, if not installed and used in accordance with the instructions, may cause harmful interference to radio communications. However, there is no guarantee that interference will not occur in a particular installation. If this equipment does cause harmful interference to radio or television reception, which can be determined by turning the equipment off and on, the user is encouraged to try to correct the interference by one or more of the following measures:

- Reorient or relocate the receiving antenna.
- Increase the separation between the equipment and receiver.
- Connect the equipment into an outlet on a circuit different from that to which the receiver is connected.
- Consult the dealer or an experienced radio/TV technician for help.



@RideHover1



@RideHover1



@RideHover1



www.Hover-1.com

WARRANTY

For warranty information, Please visit us at:
www.hover-1.com

Manufacturer: DGL Group, Ltd.
195 Raritan Center Parkway Edison, NJ 08837

Affix Serial Number Label Here:

